

2

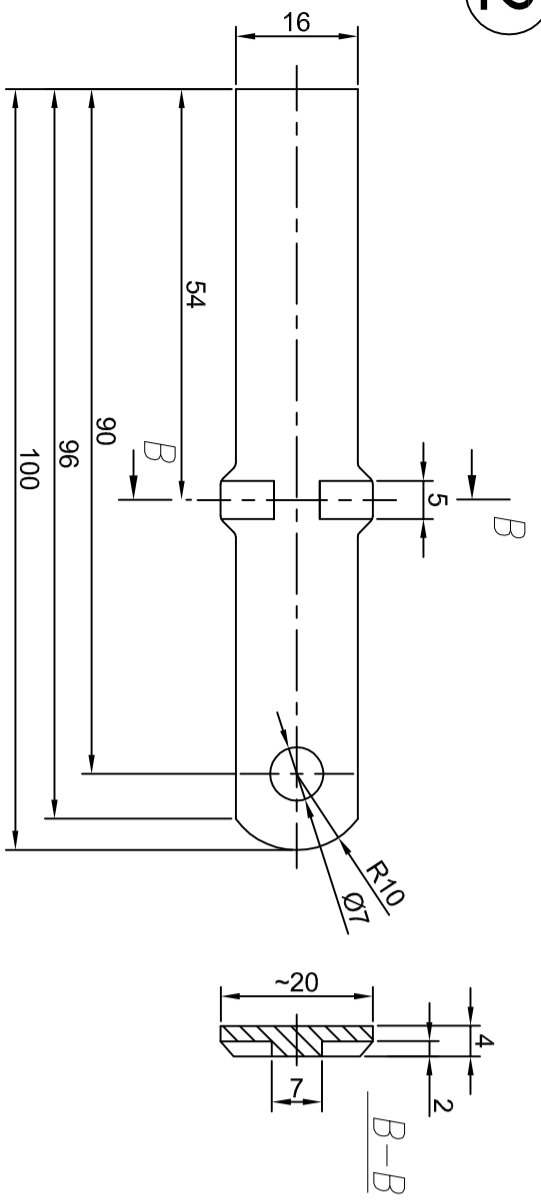

6

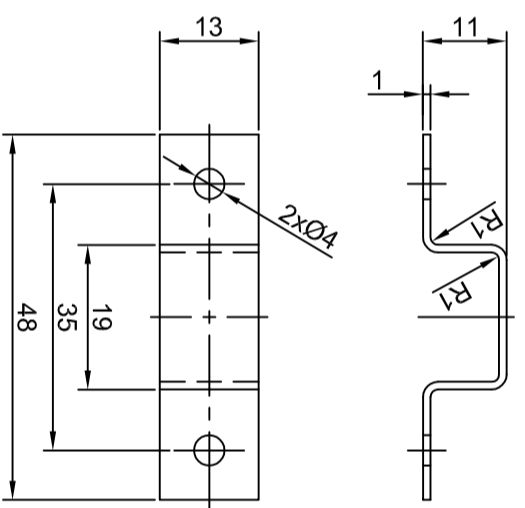

1

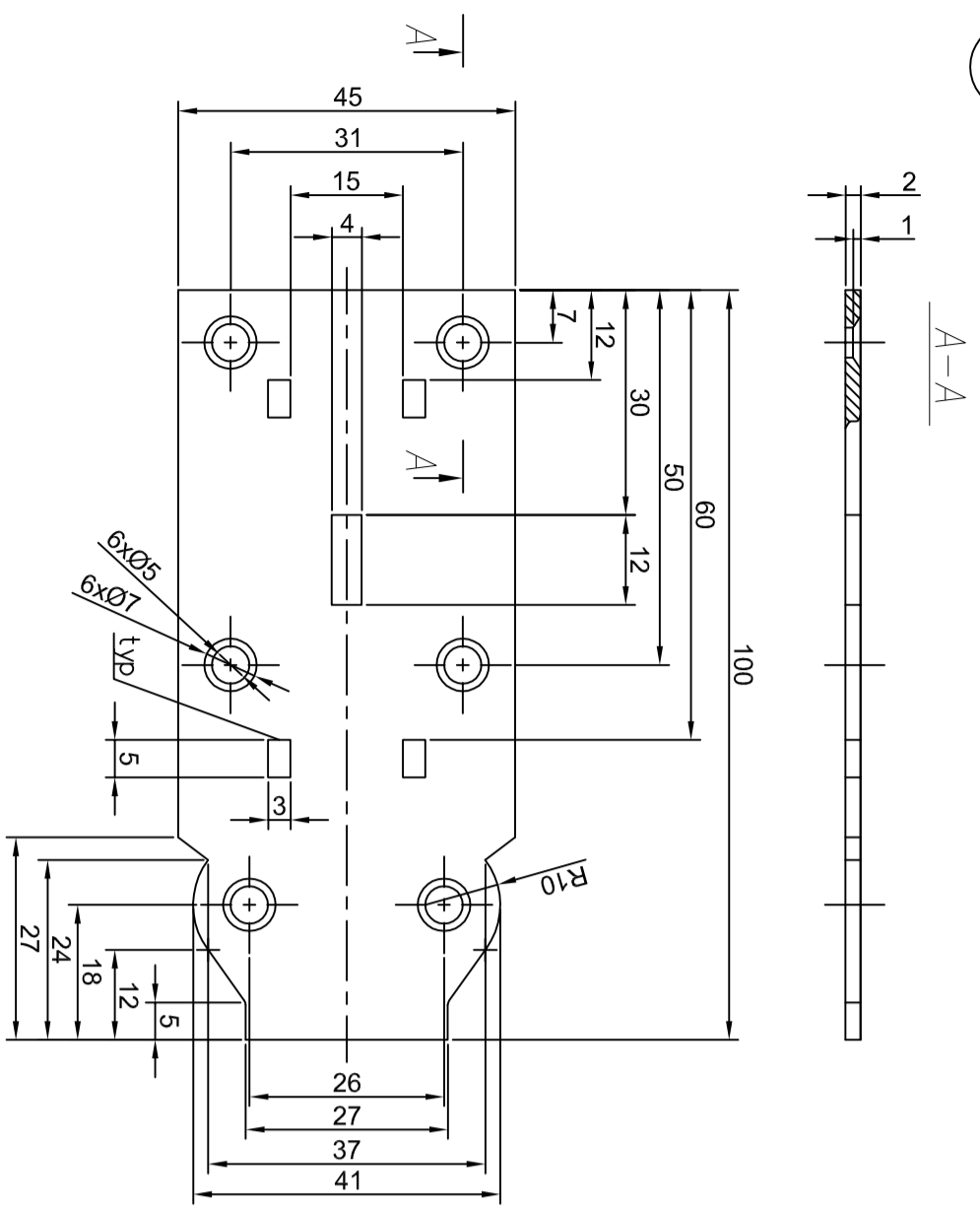

5

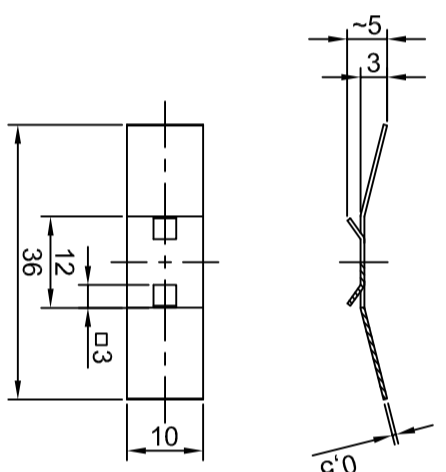

3

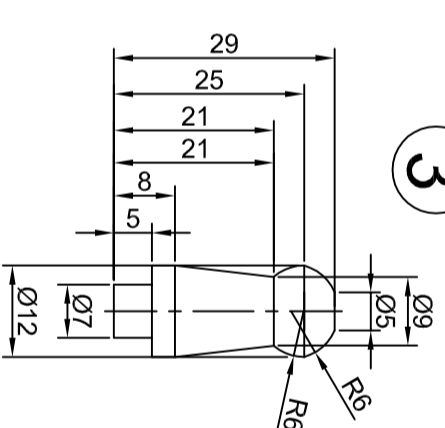

4

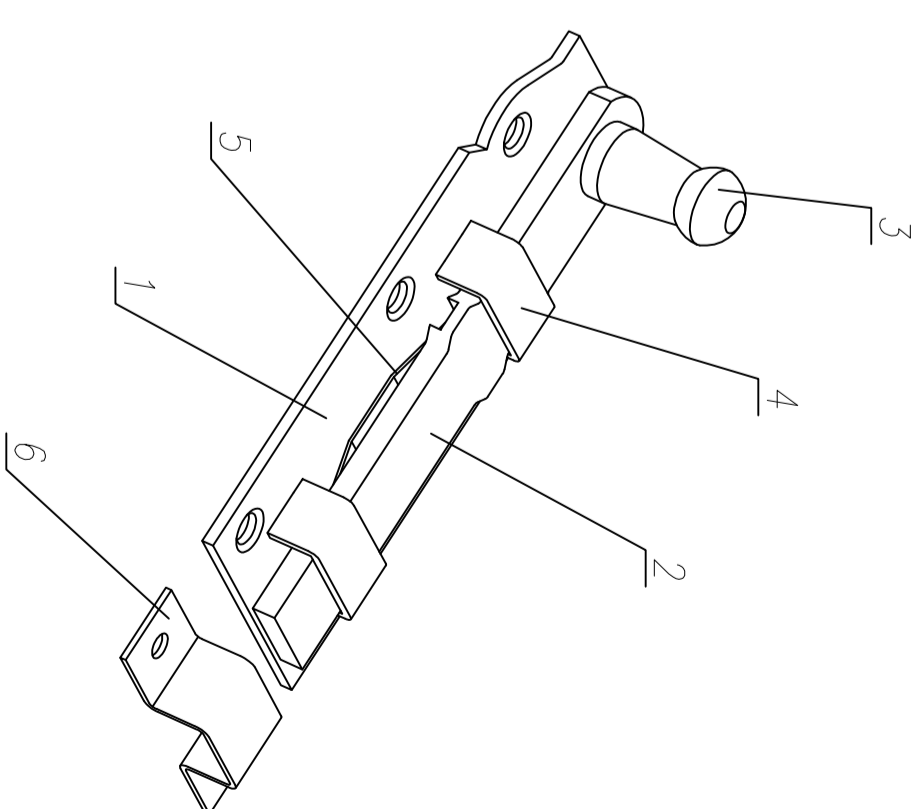
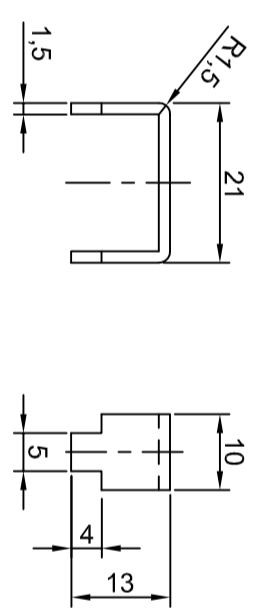

Nr.	Name	Drawing nr	Material	Amount	Weight	Notice
1	Base		DC01	1		
2	Bolt		DC01	1		
3	Holder		DC01	1		
4	Bolt fixing		DC01	2		
5	Spring		DC01	1		
6	Ear		DC01	1		

Name	Name	Date	Signature
Design	DOMAX		
Draw	B.S.		
Check	W.S		



Door bolt, straight